

Inset drawers

Application

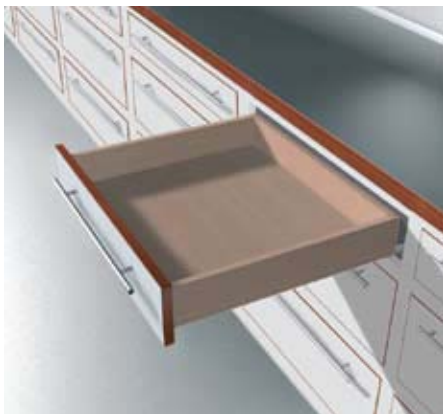

Description

- Requires increased setback of cabinet profile
- Frame applications require blocking-out behind face frame

Basic components

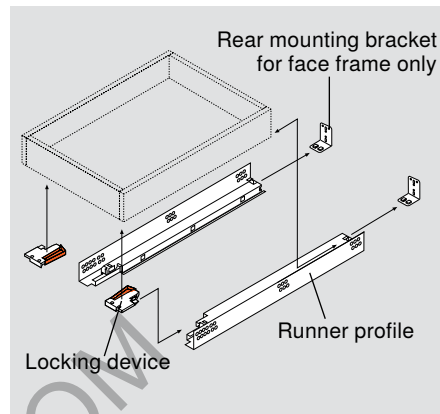

Applications

Standard application

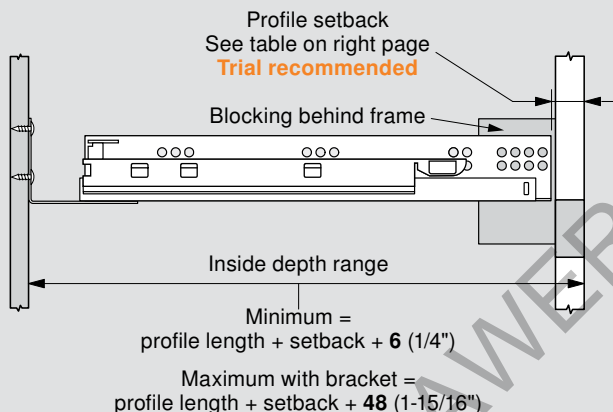

Heavy duty application

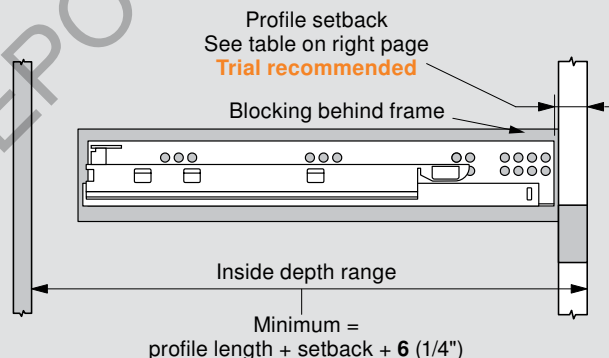

Depth adjustable locking device (inset)

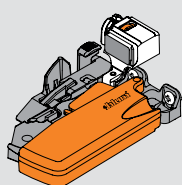

The depth adjustable locking device is specially designed for inset applications to allow installers to perfectly align drawer fronts.

- Offers 4 (3/16") out adjustment, preset at 0
- Depth adjustable +4 (3/16)
- For use with 562/568
- Designed for 13 (1/2") bottom recess

NOTE: See page 48 for other options

	Part no.
Right	T51.1700.PV R
Left	T51.1700.PV L
Installation screw	612TH

Rear mounting bracket for frame cabinets

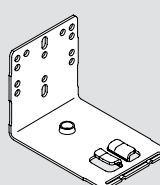

For use when installing TANDEM runners in face frame cabinets. Not necessary for panel cabinet installation.

- Two required per drawer
- Depth and side-to-side self-alignment
- Zinc-coated steel
- For use with 552/562

NOTE: See page 50 for other options

	Part no.
Non-handed bracket	295.3750.01
Installation screw	612TH

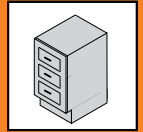

Installation

Mounting the TANDEM profile for inset application

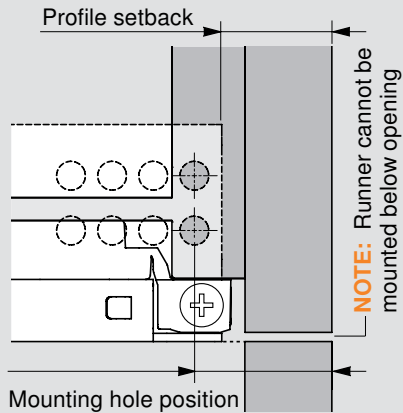

		562H				Profile setback						562F				Profile setback			
Sub front thickness	13 (1/2")	18 (11/16")	21 (13/16")	24 (15/16")	Sub front thickness	13 (1/2")	15 (9/16")	18 (11/16")	21 (13/16")	Sub front thickness	13 (1/2")	15 (9/16")	18 (11/16")	21 (13/16")	Sub front thickness	13 (1/2")	15 (9/16")	18 (11/16")	21 (13/16")
	16 (5/8")	21 (13/16")	24 (15/16")	27 (1-1/16")		16 (5/8")	18 (11/16")	21 (13/16")	24 (15/16")		16 (5/8")	18 (11/16")	21 (13/16")	24 (15/16")					
	19 (3/4")	24 (15/16")	27 (1-1/16")	30 (1-3/16")		19 (3/4")	21 (13/16")	24 (15/16")	27 (1-1/16")		19 (3/4")	21 (13/16")	24 (15/16")	27 (1-1/16")					
		16 (5/8")	19 (3/4")	22 (7/8")			16 (5/8")	19 (3/4")	22 (7/8")			16 (5/8")	19 (3/4")	22 (7/8")			16 (5/8")	19 (3/4")	22 (7/8")
				Drawer front thickness								Drawer front thickness							

- Setbacks shown are for drawer fronts that are flush with the face frame. For recessed drawer fronts or to allow for adjustability, the setback must be increased.
- After installation, adjust the locking device until the drawer front is in the desired position (out adjustment only).

NOTE: For mounting hole position add 6 mm to profile setback

Depth adjustment

Turning the adjustment screw, using a Phillips or POZI driver, allows for up to 4 (3/16") out adjustment.

