

# TANDEM plus BLUMOTION 9" concealed runners

Supplement to

TANDEM

4026.05.06

## Application

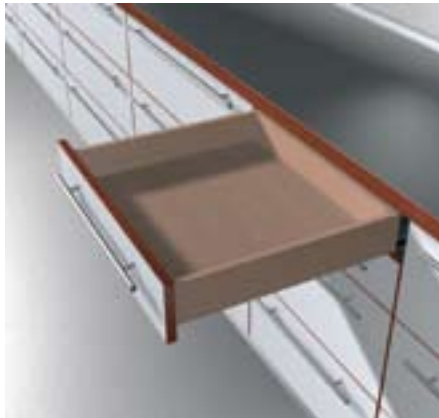

## Description

- 229mm length for 9" drawers
- Full extension concealed runners with BLUMOTION
- Rear tilt adjustment
- Concealed roller carriages with permanently lubricated synthetic rollers create a smooth running action
- Locking devices enable easy drawer insertion and removal
- Force guided right side and  $\pm 1.5$  (1/16") tolerance compensating left side
- Dynamic weight capacity of 75 lb
- Static weight capacity of 100 lb

## Basic components

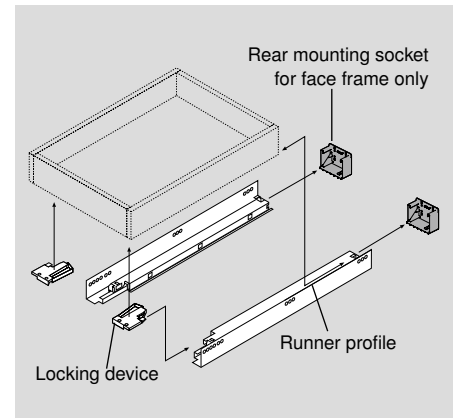

## TANDEM plus BLUMOTION Profiles (right & left)

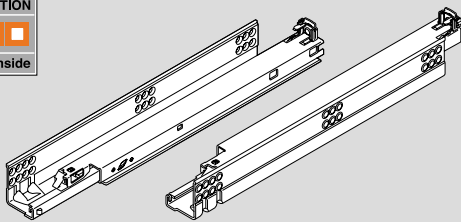

One set required per drawer

Max. drawer material	For overall cabinet depth	Profile length	Drawer length	Part No.
16 (5/8")	305 (12")	258 (10-5/32")	229 (9")	562H2290B10
19 (3/4")	305 (12")	258 (10-5/32")	229 (9")	562F2290B10
			Installation screw (wood)	707N
			Installation screw (system)	661.1300HG

## Standard locking device

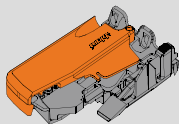

- One right and one left required per drawer
- Minimum interior drawer width 121 (4-3/4")
- Height adjustable +3 (1/8")
- Mounts with two #6 truss head screws

	Part No.
Right locking device	T51.1700.04 R
Left locking device	T51.1700.04 L
Installation screw	612TH

## Vertical mount locking device

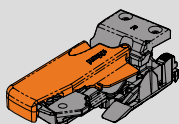

- One right and one left required per drawer
- Minimum interior drawer width 121 (4-3/4")
- Height adjustable +3 (1/8")
- Mounts with two #6 flat head wood screws

	Part No.
Right locking device	T51.1700.20 R
Left locking device	T51.1700.20 L
Installation screw	606N

## Rear mounting socket for frame cabinets

For use when installing TANDEM plus 9" runners in face frame cabinets. Not necessary for panel cabinet installation.

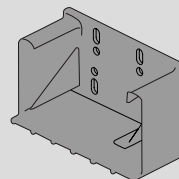

- For interior cabinet depth 266 (10-15/32") - 282 (11-3/32")
- Two required per drawer
- Side-to-side self-alignment

	Part No.
Non-handed socket	295.3700.21
Installation screw	612TH

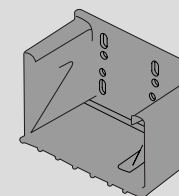

- For interior cabinet depth 283 (11-5/32") - 299 (11-25/32")
- Two required per drawer
- Side-to-side self-alignment

	Part No.
Non-handed socket	295.3700.22
Installation screw	612TH

# Specifications

## Drawer size and position

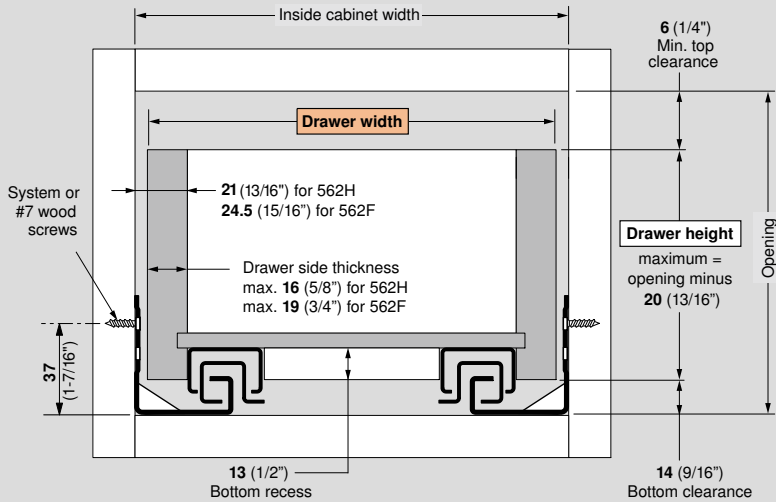

Calculating outside drawer width for 562H2290B10					
For drawer side thickness	16 (5/8")	15 (19/32")	14 (9/16")	13 (1/2")	12 (15/32")
Deduct from inside cabinet width	10 (3/8")	12 (15/32")	14 (9/16")	16 (5/8")	18 (23/32")

Calculating outside drawer width for 562F2290B10			
For drawer side thickness	19 (3/4")	18 (23/32")	17 (21/32")
Deduct from inside cabinet width	11 (7/16")	13 (1/2")	14 (9/16")

**Example:** For 21" inside cabinet width and a 3/4" thick drawer, 21" minus 7/16" = 20-9/16" drawer width

## Drawer back preparation

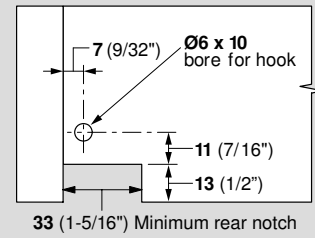

## Rear socket position

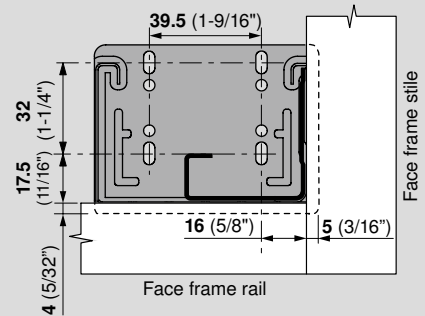

**NOTE:** For frame installation. Min. 3 screws per socket.

## Overlay application

### Panel cabinet

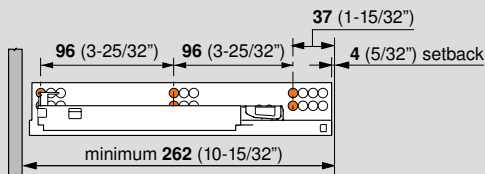

### Face frame cabinet with socket

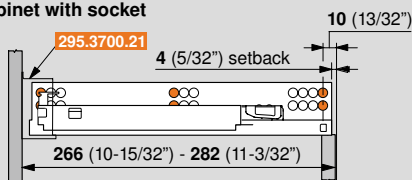

### Face frame cabinet with socket

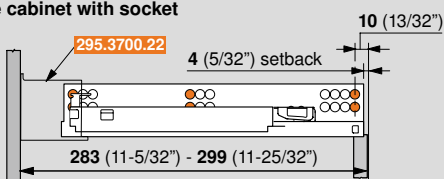

**NOTE:** To meet specified weight capacities, two screws in front and back are required.

## Inset application

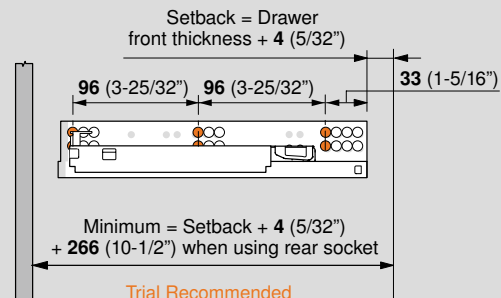

**NOTE:** To meet specified weight capacities, two screws in front and back are required.