



Accessories

Rear mount sockets for 230M and 230E runners in frame cabinets

Synthetic, neutral color

Attach with Blum 612TH screws, #6 x 1/2" trusshead

Cannot be used with 430 full extension series

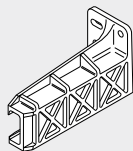

Part No.

230M RH & LH Socket Set	602320
230M RH	602300
230M LH	602301

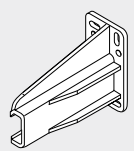

Part No.

230E RH & LH Socket Set	601962-VH21
230E RH	601960
230E LH	601961

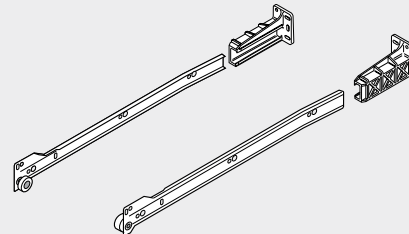

Cabinet profile spacers

To space runners away from the cabinet side to clear door protrusion on interior roll-out trays.

Two thicknesses available that can be stacked up to 24 (5/16")

Synthetic, neutral color

Part No.

A 8 (5/16") with Ø5 (3/16") x 11 dowel for linebore mounting	320M0188
--	----------

B 4 (5/32") stackable	320M0048
-----------------------	----------

C 8 (5/16") stackable	320M0088
-----------------------	----------

Heavy duty spacer
Synthetic, neutral color

D 32 (1-1/4") x 19 (3/4")	602750
---------------------------	--------

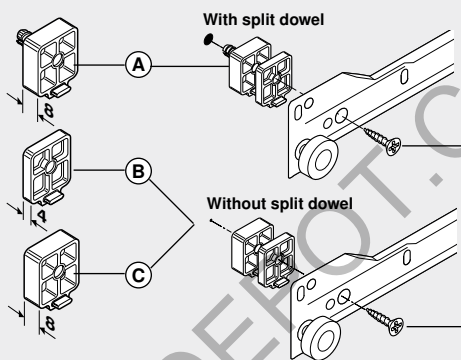

Use #6 FH screw that penetrates cabinet side at least 13 (1/2")

Heavy duty spacer

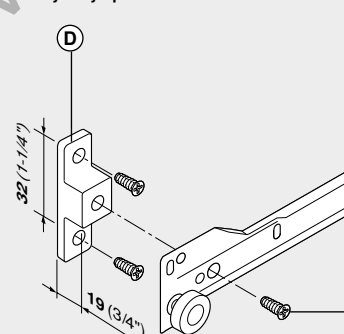

Use 3 deep thread system screws to attach runner to spacer and spacer to cabinet side

Important: Use spacers on front, middle and rear of each cabinet profile for adequate support.

Door protectors

For pull-out surrounds to prevent damage to doors.

Fixed to the underside of the drawer. For 230M and 430E runners. Symmetrical. Epoxy coated steel, with synthetic rollers, cream color.

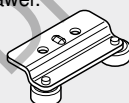

Part No.

Door protector	298.2200
----------------	----------

Space requirements

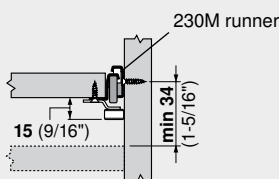

Assembly

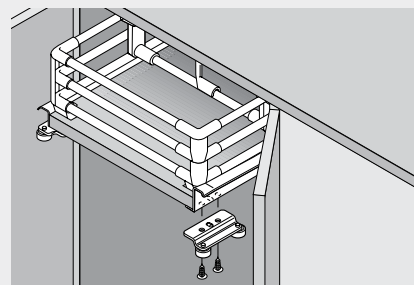

Screws and bumpers

Deep thread wood screws
Nickel plated



Part No.

#6 x 5/8", #2 Phillips	606N
#6 x 5/8", #2 POZI	606P

Zinc plated
#6 x 1/2", #2 Phillips



Part No.

#6 x 1/2", #2 Phillips	612TH
------------------------	-------

Deep thread system screws
Pilot bore Ø5 (3/16") hole
Nickel plated



Part No.

11.5 (7/16"), #2 POZI	661.1150
13 (1/2"), #2 POZI	661.1300

Drawer bumper stops
Cushions drawer closing
Self-adhesive back, clear



Part No.

6 (1/4") dia. x 1.5 (1/16") thk.	FX4041
10 (3/8") dia. x 3 (1/8") thk.	SJ5312